

T3[®] Short Implant Surgical Manual

Preservation By Design[®]



Table of Contents

Introduction And Treatment Planning Considerations	1
Preoperative Planning Considerations	2-3
Top-Down Treatment Planning Considerations	4
Surgical Precautions	5
Twist Drill Depth Marking System	6
Quick Reference Crestal Surgical Protocol	7-8

Crestal Surgical Protocol:

T3 Short External Hex 5.0 mmD Implants	9-10
T3 Short External Hex 6.0 mmD Implants	11-12
Crestal Implant Placement Protocol	13-14
Surgical Indexing	15
Single-Stage Treatment Protocol	16
Ordering Information	17

IMPORTANT PRODUCT INFORMATION

Biomet 3i Dental Implants

For detailed product information on all Biomet 3i Dental Implants, refer to the Biomet 3i Dental Implant IFU (P-IIS086GI) located at ifu.biomet3i.com.

Biomet 3i Kits and Instruments

The recommended procedure for Cleaning and Sterilization of Biomet 3i Kits and Instruments (P-IFCSCSS) is available at ifu.biomet3i.com.

These instructions were designed to serve as a reference guide for dental practitioners utilizing T3 Short Implants and Surgical Instruments.

The design of T3 Short Implants and surgical instruments enable the practitioner to place implants in edentulous or partially edentulous mandibles or maxillae in order to support fixed and removable bridgework, single-tooth crowns and overdentures.

General Information:

The success of any dental implant system depends upon proper use of the components and instrumentation. This manual is not intended for use as a substitute for professional training and experience; it is not comprised of clinical advice. The clinician should use medically sound treatment planning and procedures appropriate for each patient's individual case for predictable results.

Treatment Considerations:

Patient Evaluation And Selection

Several important factors must be considered when evaluating a patient prior to implant surgery. The pre-surgical evaluation must include a careful and detailed assessment of the patient's general health, current medical status, medical history, oral hygiene, motivation and expectations. Factors such as tobacco use, masticatory function and alcohol consumption should also be considered.

In addition, the clinician should determine if the patient presents an acceptable anatomical basis conducive to implant placement. An extensive intraoral examination should be performed to evaluate the oral cavity for any potential bone or soft-tissue pathology. The examiner should also determine the periodontal status of the remaining teeth, the health of the soft tissue and the presence of occlusal abnormalities such as bruxism or crossbite. The presence of other conditions that could adversely affect any existing natural dentition or healthy soft tissue surrounding the implant should also be evaluated.

Diseases of the mucous membrane and connective tissues, pathologic bone disease and severe malocclusion can affect the determination of whether a patient is a suitable implant candidate.

The use of anticoagulants and the existence of metabolic diseases, such as diabetes, allergies, chronic renal or cardiac disease and blood dyscrasia may significantly influence the patient's ability to successfully undergo implant procedures.

Bone Densities

The protocols detailed in this Surgical Manual have been developed to include more specific information about drill selection when working in various bone densities. However, the clinician is responsible for assessing bone density and anatomy when determining the appropriate protocol.

The various bone densities can be characterized by the following:

Dense (Type I) – A thick cortical layer and a very high density trabecular core

Medium (Type II & III) – A cortical layer of moderate thickness with a reasonably dense trabecular core

Soft (Type IV) – A thin cortical layer and a low density trabecular core

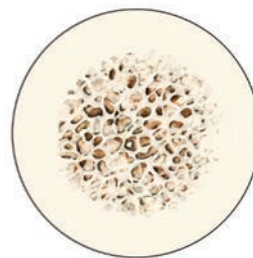

Dense (Type I)



Medium (Type II)



Medium (Type III)



Soft (Type IV)

Preoperative Planning:

Proper treatment planning, as well as the selection of the proper implant length and diameter, are crucial to the long-term success of the implant and restoration.

Before an implant can be selected, the anatomical foundation available to receive the implant must be carefully assessed. Several steps should be taken to complete the evaluation:

1. Clinical examination of the oral cavity can provide important information about the health of the soft tissue at the proposed implant site. Tissue tone and the state of the superficial tissues should be evaluated. In addition, the patient should demonstrate an adequate dimension of attached gingiva or keratinized tissue at the site selected for implantation. In partially edentulous cases, the periodontal status of the remaining dentition should be assessed and interaction between the implant restoration and the adjacent natural dentition should be considered.
2. The bony foundation and ridge need to be clinically analyzed to ensure the presence of proper dimensions and the amount of bone for implant placement. At least one millimeter of bone should be present at the buccal and lingual aspects of the implant following placement. During the planning stage, it is useful to measure the existing bone foundation.

NOTE: Please ensure as many implants as necessary are used for a fully stable restoration.

CT Scans:

Computed tomography (CT) scans help surgeons view parts of the body with three-dimensional images. Image-guided surgical planning allows surgeons to see anatomical landmarks such as nerves, sinus cavities and bony structures in order to plan for the placement of dental implants and prostheses.

Through the use of CT scans, clinicians should be able to more precisely measure the locations of anatomical structures, dimensions of the underlying bone and ascertain bone densities in order to plan and treat clinically demanding cases.

Radiographic Transparencies:

The vertical height of the bone can be determined radiographically. Accurate measurement of the vertical dimension on the radiograph facilitates the selection of the appropriate implant length. This should help to avoid implant placement into the maxillary sinus, the floor of the nose or the mandibular canal, and should prevent perforation of the inferior aspect of the mandible. Measurements can be made directly on the panoramic radiograph using a millimeter ruler. Corrections should be made for the degree of enlargement or reduction produced by the particular radiographic equipment.

Radiographic marking balls of a known dimension can be embedded in a plastic template prior to radiographic examination. Once the radiograph is taken and the metal marking balls are visible on the image, measurements can be taken to determine the amount of bone available for implant placement. (See instructions on page 6).

To calculate the distortion factor, a simple formula can be utilized: $(5 \div A) \times B =$ the amount of actual bone available. Formula Key =

- Radiographic marking ball = 5.0 mm in diameter.
- A = Size of marking ball image on radiograph.
- B = Length in millimeters on the radiograph of available bone between the crest of the ridge and the inferior alveolar canal.

Example:

A = 6.5 mm

B = 14 mm

Therefore: $(5 \div 6.5) \times 14 = 10.76$ mm actual bone available

NOTE: A 2.0 mm margin of safety, from the apical end of the implant to any adjacent vital structure, should be considered.

Marking Ball Image
(6.5 mm on this radiograph)

Inferior Alveolar
Nerve Canal

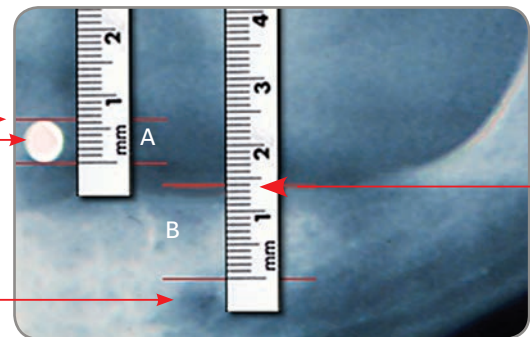

Radiographic Transparencies Instructional Steps:

A dental implant radiographic transparency supports the preoperative implant treatment planning process. A radiographic transparency is overlaid onto a radiograph to assist the clinician in the preoperative determination of options for implant length and diameter. It is used in conjunction with a 5.0 mm radiographic marking ball. Representations of the implant and the 5.0 mm radiographic marking ball are shown on the radiographic transparency at 100% and 125% scales.

Visually inspect the transparency before each use for damage. The transparency should not be used if damaged or deteriorated. The following steps outline the proper use of the radiographic transparency in conjunction with the 5.0 mm radiographic marking ball(s) during preoperative planning:

1. Overlay the 100% and 125% scaled 5.0 mm circular radiograph ball outline found on the transparency over the 5.0 mm radiographic ball image on the radiograph and determine which outline is closest to the diameter of the radiographic ball image on the radiograph. If the radiographic ball image on the radiograph extends outside the circular border of the radiographic ball outline on the 100% scale, use the 125% scale for measurement estimations. If the radiographic ball image extends outside the circular border of the radiographic ball outline on the 125% scale, DO NOT use this radiographic transparency and refer to the Radiographic Marking Balls procedure to determine approximate bone height (See section on calculation of distortion factor on page 5).

NOTE: The radiographic ball should maintain its spherical shape on the radiograph, otherwise distortion that cannot be measured may have occurred. If this happens, it is recommended that a new radiograph be taken.

2. Select the scale (100% or 125%) to use based on which circular radiograph ball outline best matches the diameter of the radiographic ball image on the radiograph.
3. To determine an approximation of available vertical bone height at the proposed implant site, align the zero mark on the selected ruler (100% or 125%) to the crest of the edentulous ridge and measure the length between the crest and anatomical structures in the proposed implant site including the floor of the maxillary sinus, the floor of the nose and the mandibular canal.

NOTE: A minimum of 2.0 mm margin of safety, from the apical end of the implant to the adjacent vital structure, should be considered.

4. Overlay the implant silhouette corresponding to the selected scale (100% or 125%) onto the proposed implant site to visually estimate if adequate vertical bone height is present for the selected implant length.

NOTE: The intended use of this device is exclusively for preoperative planning and to be used as a guide. Implant length and diameter should not be determined solely by relying on the radiographic transparency.

In its simplest form, top-down treatment planning refers to a guideline whereby the desired restorative result is considered first, leading to consideration of the appropriate prosthetic platform and subsequent implant selection based on bony anatomy and the size of the missing tooth. T3 Short Implants are recommended for use in the posterior region to help prevent the need for sinus lifts or mandibular nerve repositioning.

	5.0 mmD	6.0 mmD
Anterior		
Posterior	•	•

A top-down treatment planning methodology will provide maximum biomechanical stability and allow for soft-tissue flaring by utilizing an implant with a prosthetic platform slightly smaller in diameter than the emergence diameter of the tooth being replaced.¹ Implant and healing abutment selections are based upon the relationship of several key measurements:

- The emerging dimension of the crown in relation to the diameter of the prosthetic platform of the implant
- The height and diameter of the intended restoration at the tissue exit point
- The bone volume at the implant site in relation to the diameter of the implant body

The Emergence Profile EP® Healing Abutment System consists of healing abutments of various diameters and heights designed for shaping the soft tissue to help replicate the geometry and gingival contours of natural dentition.

T3 Short Implants are compatible with both straight and pre-angled ex hex restorative components. T3 Short Implants are not compatible with Low Profile Angled Abutments.

NOTE: Manually platform switching the healing and definitive abutments may aid in preserving crestal bone and tissue height.

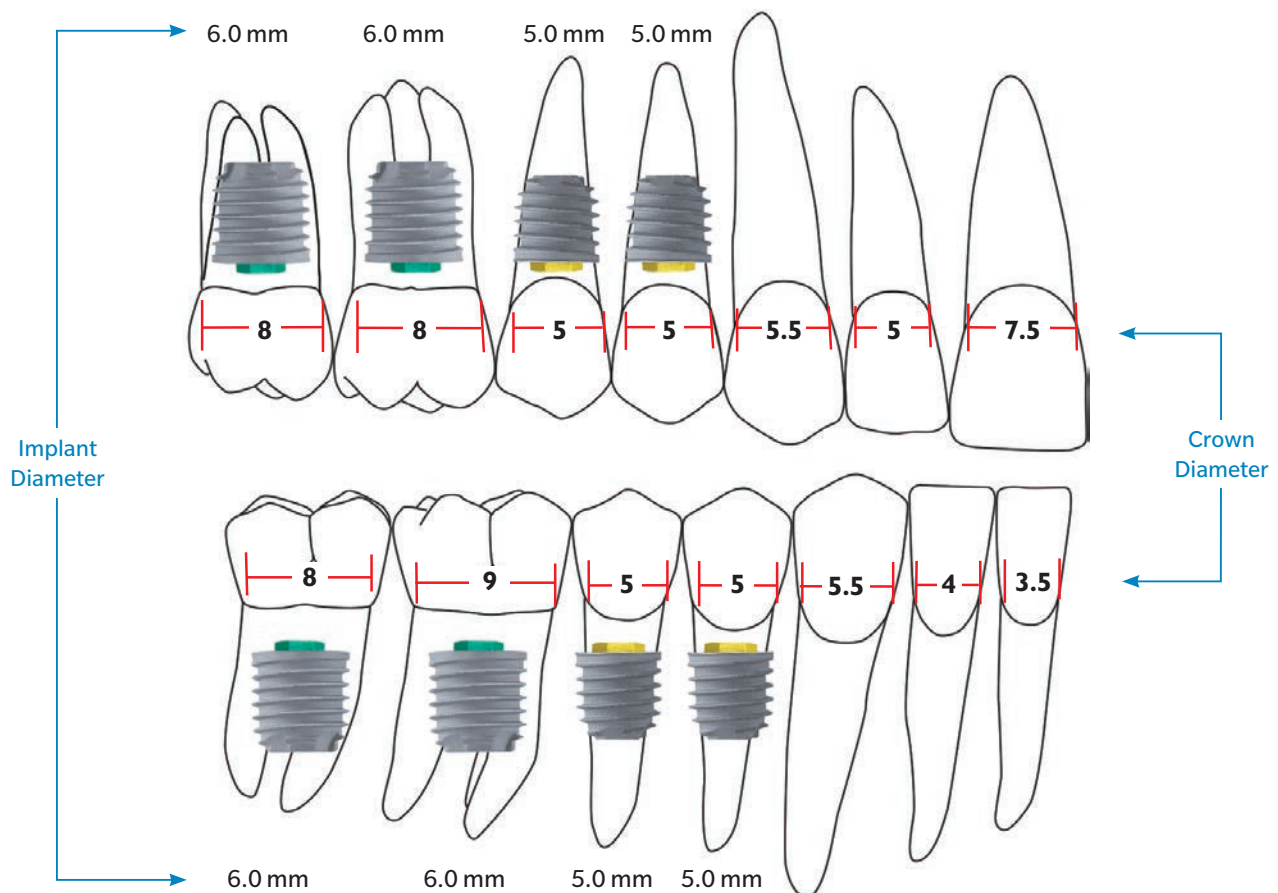

1. Boitel N,* Andreoni C, Grunder U,* Naef R,* Meyenberg K.* A Three Year Prospective, Multicenter, Randomized-Controlled Study Evaluating Platform-Switching for the Preservation of Peri-Implant Bone Levels. Academy Of Osseointegration, 26th Annual Meeting: 2011 March 3-5; Washington DC.
 * These clinicians have or had financial relationships with BIOMET 3i LLC resulting from speaking engagements, consulting engagements and other retained services.

Clinical Considerations:

Actual bone contours can only be evaluated after tissue flaps have been reflected at the time of surgery or with preoperative high quality CT scans. Even if bone dimensions are meticulously measured prior to surgery, the doctor and patient must accept the possibility that inadequate bone anatomy may be discovered during surgery and preclude implant placement.

During the presurgical planning phase, it is important to determine the interocclusal clearance - the actual space available between the alveolar crest and the opposing dentition - to confirm that the available space will accommodate the proposed abutment and the definitive restoration. The height required by the abutment may vary with the type of abutment; therefore, the surgeon and restorative dentist should carefully evaluate the abutment size. The definitive prosthesis should be conceptually designed prior to the placement of the implant.

Diagnostic casts can be used preoperatively to evaluate the residual ridge and to determine the position and angulation of all implants. These casts should allow the clinician to evaluate the opposing dentition and its effect on implant position. A surgical guide stent, which is critical for determining the precise position and angulation of the implant, can be constructed on the diagnostic cast.

Several software companies offer planning software that allow clinicians to plan implant placement three-dimensionally in conjunction with CT scans. From plans created in these software packages, surgical guides can be made to aid in the pre-angulation and placement of implants.

To help prevent damage to the bone tissue and to help prevent compromising osseointegration by overheating the bone during drilling, copious irrigation with sterile water or saline solution is mandatory during all drilling procedures.

Bone surgery utilizes a high-torque electric drilling unit that can be operated in forward and reverse modes at speeds ranging from 0 to 2000 rpm, depending on the surgical requirements. Sharp instruments of the highest quality should be utilized during implant site preparation to reduce possible overheating and trauma to the bone. Minimizing trauma enhances the potential for successful osseointegration.

The time elapsed between surgical placement of the implant and definitive abutment placement can vary or be modified, depending on the quality of the bone at the implantation site, bony response to the implant surface and other implanted materials and the surgeon's assessment of the patient's bone density at the time of the surgical procedure. Extreme care must be taken to avoid excessive force being applied to the implant during this healing period.

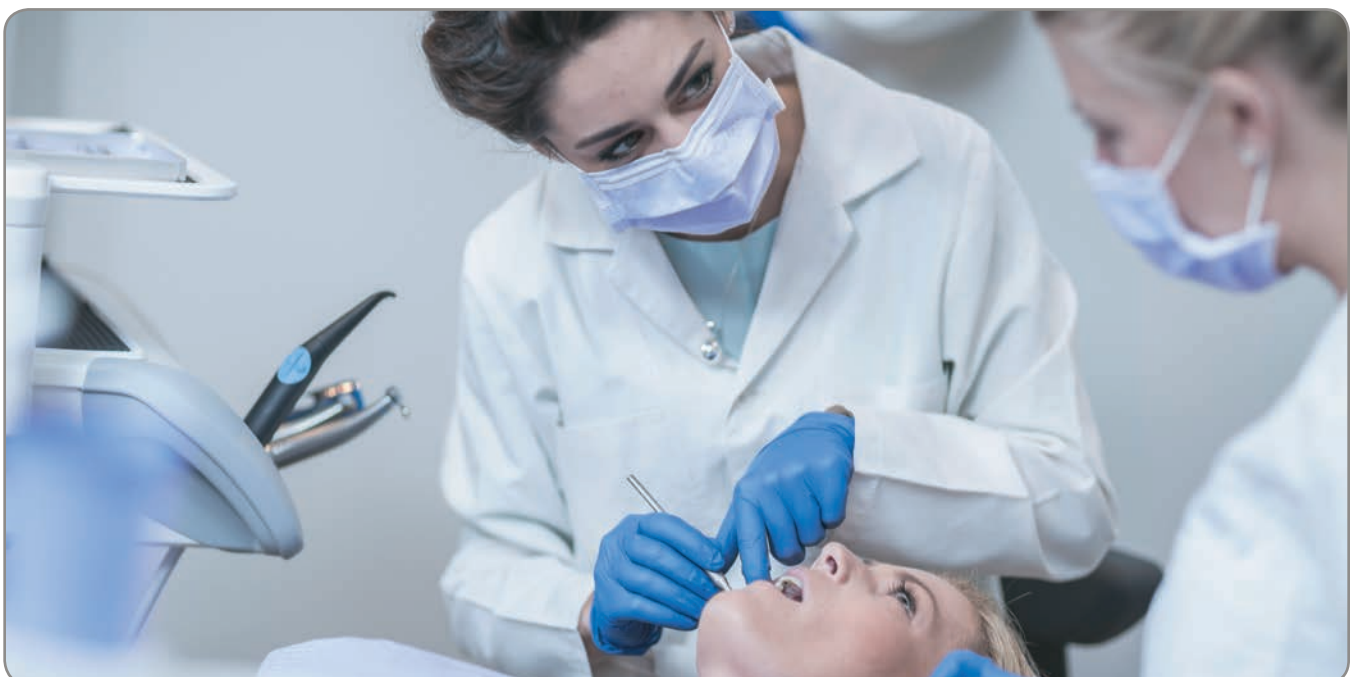

ACT® Reusable Short Twist Drills

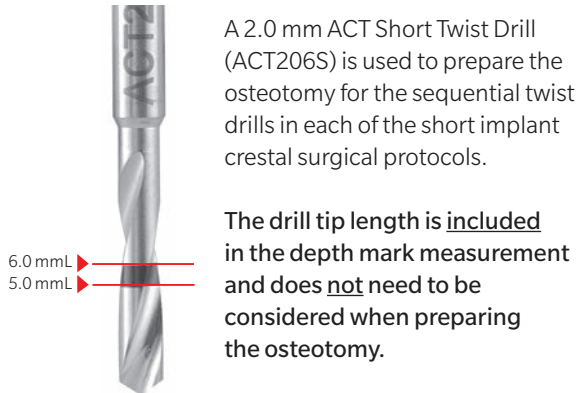

Reusable Shaping Drills

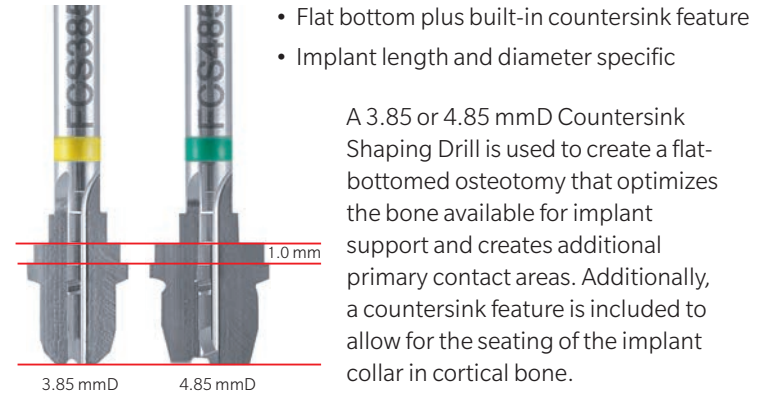

Standard Crestal Protocol

1.0 mm Cover Screw

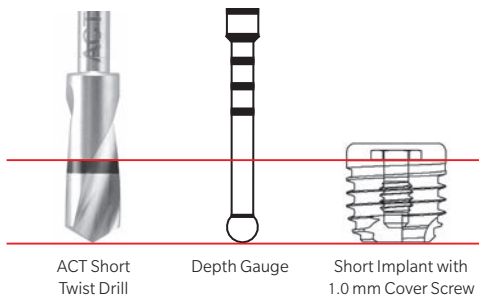

The depth mark measurement system provides a mark on the drill that corresponds to the placement depth of the implant, utilizing well-established procedures.

The drilling depth using the Twist Drill will vary depending on the type of placement that's related to the bone crest. **The depth marks on the ACT Short Twist Drills are specific for crestal implant placement only.** These drills have no specific depth marks for supracrestal or subcrestal placement.

T3 Short Implants are packaged with a 1.0 mm height Cover Screw. With **crestal** placement, this Cover Screw will be 1.0 mm above the bone crest.

Crestal Placement

The implant platform will be at the bone crest.

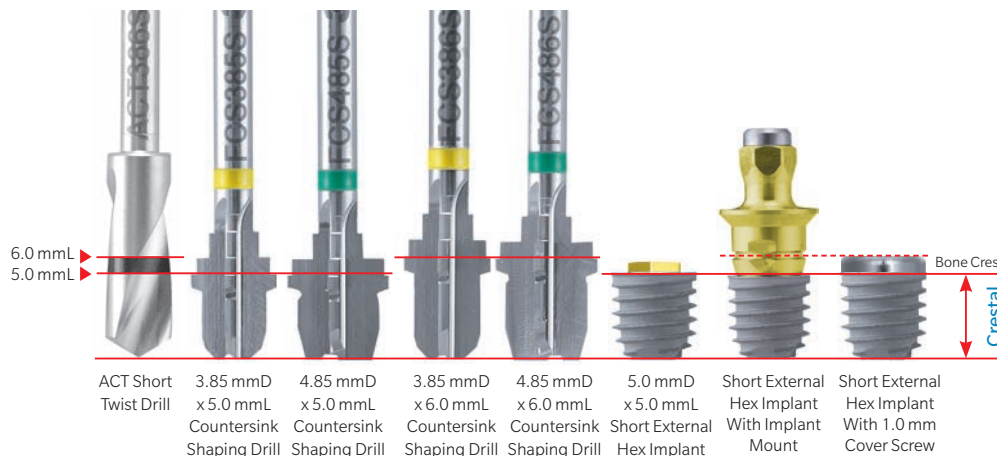

For 5.0 mmL implant placement, stop drilling **at the bottom** of the ACT Short Twist Drill depth mark.

For 6.0 mmL implant placement, stop drilling **at the top** of the ACT Short Twist Drill depth mark.

The **top** of the Shaping Drill marks the length of the implant with a standard 1.0 mm Cover Screw in place.

The landmarks (grooves) on the External Hex Implant Mount act as a reference during implant placement.

Important Considerations:

- The recommended drill speed for twist drills 3.85 mm diameter or smaller is 1200 – 1500 rpm.
- The recommended drill speed for twist drills 4.25 mm diameter or larger is 900 rpm.
- The recommended drill speed for shaping drills is 1200 – 1500 rpm.
- The shaping drills must be used without pumping actions.
- The recommended implant placement speed is 15 – 20 rpm.
- Do not initiate implant placement with the hand ratchet as hand torquing could result in off-angle placement of the implant.
- Use the drill motor handpiece to start implant placement to ensure the implant tracks / goes into the osteotomy in the same direction as drilled.
- Verify that the drill is engaged/retained within the locking mechanism of the drill motor handpiece, in order to prevent accidental swallowing or aspiration of the drill.
- When insertion torque exceeds 50 Ncm, hand ratcheting is necessary in order to fully seat the implant.
- It is recommended that reusable drills be replaced after 15 uses.
- It is recommended that manual platform switching be used to maximize crestal bone preservation.
- Tapping with a dense bone tap is required in dense bone (Type 1).

Important Note:

Exceeding insertion torque of more than 90 Ncm may deform or strip the implant placement mount or the implant's external hex and may possibly delay the surgical procedure.



T3 Short External Hex 5.0 mmD x 5.0 mmL Implants

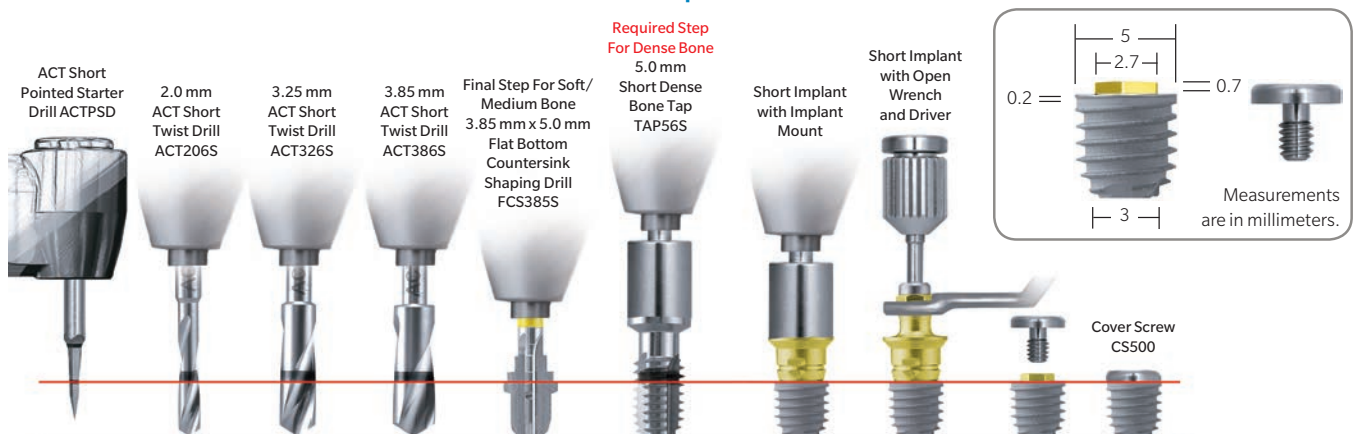

T3 Short External Hex 5.0 mmD x 6.0 mmL Implants



T3 Short External Hex 6.0 mmD x 5.0 mmL Implants



T3 Short External Hex 6.0 mmD x 6.0 mmL Implants

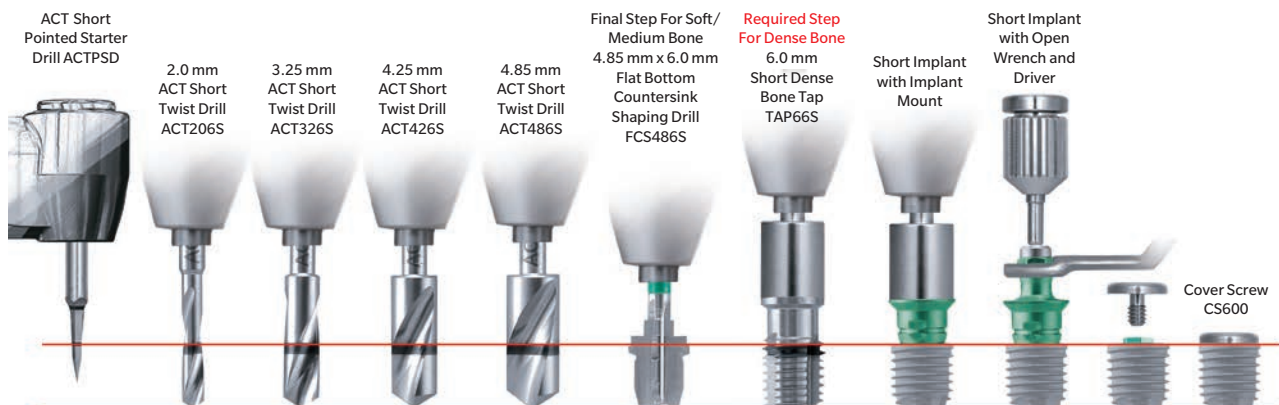

5.0 mmD x 5.0 mmL & 5.0 mmD x 6.0 mmL Implants



1. Once the implant site has been determined, mark the site with the ACT Short Pointed Starter Drill and penetrate the cortical bone to the first depth mark on the drill. The recommended drill speed is 1200 – 1500 rpm.

Use copious irrigation with sterile water or saline solution to prevent overheating of the bone during high speed drilling.

- Instrument needed:
ACT Short Pointed Starter Drill (ACTPSD)

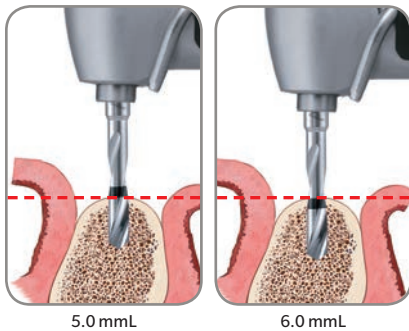

2. Proceed with the initial 2.0 mm ACT Short Twist Drill. Drill to the bottom of the depth mark for 5.0 mm length implants and drill to the top of the depth mark for 6.0 mm length implants. The recommended drill speed is 1200 – 1500 rpm.

- Instrument needed:
2.0 mm ACT Short Twist Drill (ACT206S)

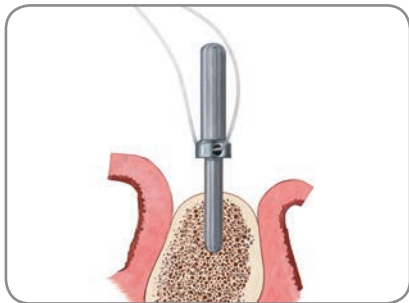

3. Verify the direction and position of the preparation by inserting the narrow end of the Direction Indicator (available separately) into the osteotomy. Thread a suture through the hole to prevent accidental swallowing.

At this step, a Gelb Radiographic Depth Gauge may also be used.

- Instruments needed:
Direction Indicator (DI100 or DI2310)
Gelb Radiographic Depth Gauge (XDGxx)

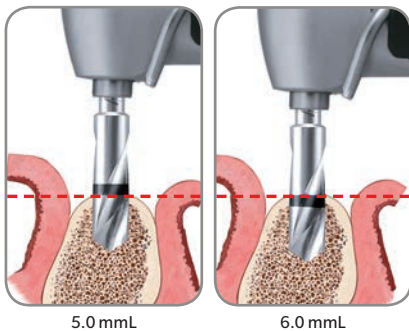

4. Once proper alignment is verified using the Direction Indicator, proceed with the 3.25 mm ACT Short Twist Drill. Drill to the bottom of the depth mark for 5.0 mm length implants and drill to the top of the depth mark for 6.0 mm length implants. The recommended drill speed is 1200 – 1500 rpm.

- Instrument needed:
3.25 mm ACT Short Twist Drill (ACT326S)

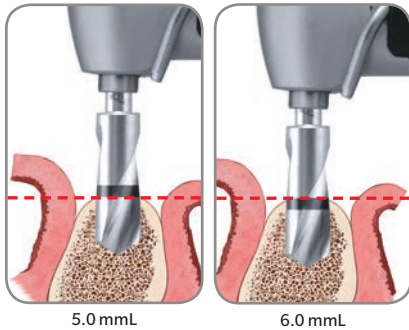

5. Once the coronal aspect of the osteotomy has been prepared, proceed with the 3.85 mm ACT Short Twist Drill. Drill to the bottom of the depth mark for 5.0 mm length implants and drill to the top of the depth mark for 6.0 mm length implants.

The recommended drill speed is 1200 – 1500 rpm.

- Instrument needed:
3.85 mm ACT Short Twist Drill (ACT386S)

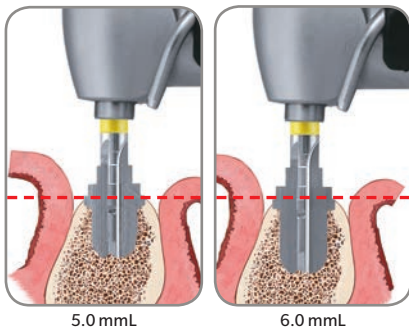

6. Proceed with the 3.85 mm Short Shaping Drill with a yellow band indicating that it's for use with a 5.0 mmD T3 Short Implant. The recommended drill speed is 1200 – 1500 rpm.

- Instrument needed:
3.85 mm x 5.0 mm Short Flat Bottom Countersink Shaping Drill (FCS385S)
Or
3.85 mm x 6.0 mm Short Flat Bottom Countersink Shaping Drill (FCS386S)

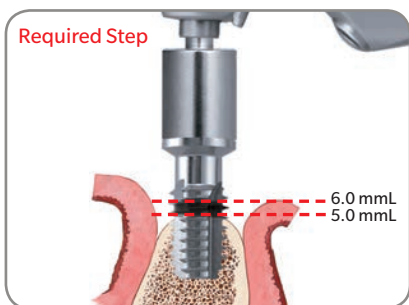

Required Tapping Step: For dense bone (Type I)

If placing a T3 Short Implant in dense bone (Type I), tapping with a 5.0 mm Short Dense Bone Tap is required.

Using the Handpiece Connector, advance the tap into the prepared site at approximately 15 – 20 rpm. It is not uncommon for the drill unit to stall before the tap is completely seated. Final seating of the Short Dense Bone Tap may require the use of the Ratchet Extension and the Ratchet Wrench.

To avoid stripping the site, be careful not to tap beyond the osteotomy depth.

- Instruments needed:
Handpiece Connector (MDR10)
5.0 mm Short Dense Bone Tap (TAP56S)
Ratchet Extension (RE100 or RE200)
Ratchet Wrench (WR150) or High Torque Indicating Ratchet Wrench (H-TIRW)

Proceed to step 1 on page 16 for implant placement.

6.0 mmD x 5.0 mmL & 6.0 mmD x 6.0 mmL Implants

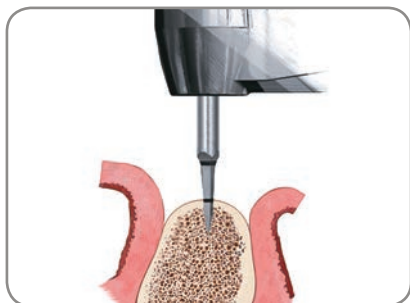

1. Once the implant site has been determined, mark the site with the ACT Short Pointed Starter Drill and penetrate the cortical bone to the first depth mark on the drill. The recommended drill speed is 1200 – 1500 rpm.

Use copious irrigation with sterile water or saline solution to prevent overheating of the bone during high speed drilling.

- Instrument needed:
ACT Short Pointed Starter Drill (ACTPSD)

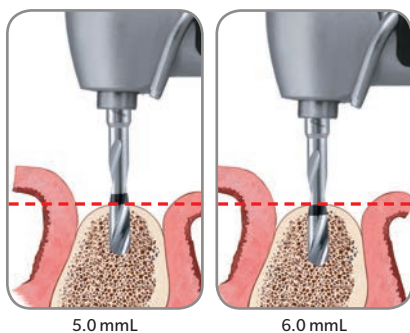

2. Proceed with the initial 2.0 mm ACT Short Twist Drill. Drill to the bottom of the depth mark for 5.0 mm length implants and drill to the top of the depth mark for 6.0 mm length implants. The recommended drill speed is 1200 – 1500 rpm.

- Instrument needed:
2.0 mm ACT Short Twist Drill (ACT206S)

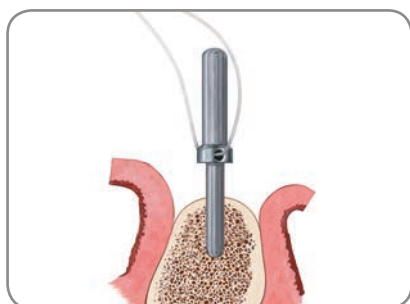

3. Verify the direction and position of the preparation by inserting the narrow end of the Direction Indicator (available separately) into the osteotomy. Thread a suture through the hole to prevent accidental swallowing.

At this step, a Gelb Radiographic Depth Gauge may also be used.

- Instruments needed:
Direction Indicator (DI100 or DI2310)
Gelb Radiographic Depth Gauge (XDGxx)

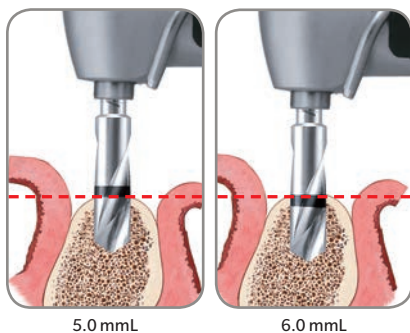

4. Once proper alignment is verified using the Direction Indicator, proceed with the 3.25 mm ACT Short Twist Drill. Drill to the bottom of the depth mark for 5.0 mm length implants and drill to the top of the depth mark for 6.0 mm length implants. The recommended drill speed is 1200 – 1500 rpm.

- Instrument needed:
3.25 mm ACT Short Twist Drill (ACT326S)

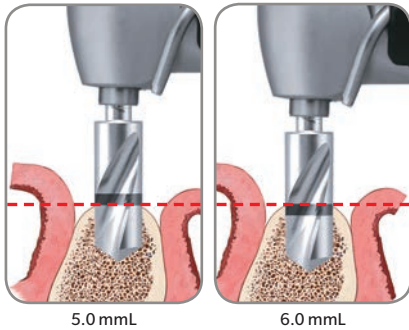

5. Once the coronal aspect of the osteotomy has been prepared, proceed with the 4.25 mm ACT Short Twist Drill. Drill to the bottom of the depth mark for 5.0 mm length implants and drill to the top of the depth mark for 6.0 mm length implants. The recommended drill speed is 900 rpm.

- Instrument needed:
4.25 mm ACT Short Twist Drill (ACT426S)

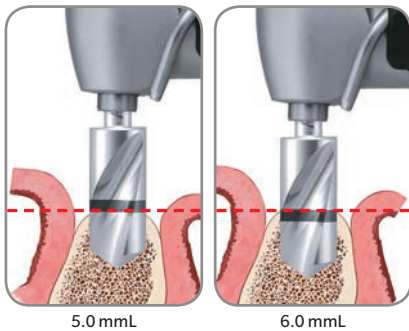

6. Proceed with the 4.85 mm ACT Short Twist Drill. Drill to the bottom of the depth mark for 5.0 mm length implants and drill to the top of the depth mark for 6.0 mm length implants. The recommended drill speed is 900 rpm.

- Instrument needed:
4.85 mm ACT Short Twist Drill (ACT486S)

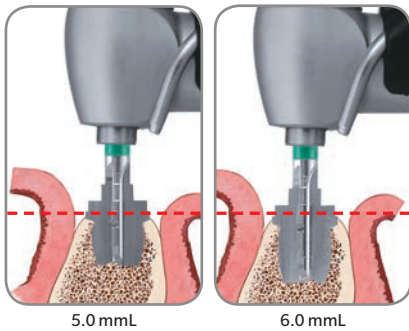

7. Proceed with the 4.85 mm Short Shaping Drill with a green band indicating that it's for use with a 6.0 mmD T3 Short Implant. The recommended drill speed is 1200 – 1500 rpm.

- Instruments needed:
4.85 mm x 5.0 mm Short Flat Bottom Countersink Shaping Drill (FCS485S)
Or
4.85 mm x 6.0 mm Short Flat Bottom Countersink Shaping Drill (FCS486S)

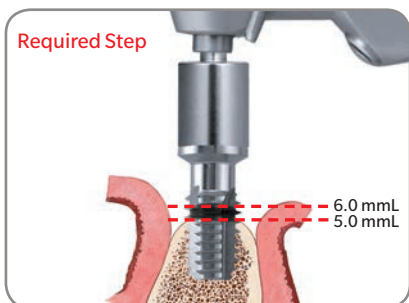

Required Tapping Step: For dense bone (Type I)

If placing a T3 Short Implant in dense bone (Type I), tapping with a 6.0 mm Short Dense Bone Tap is required.

Using the Handpiece Connector, advance the tap into the prepared site at approximately 15 – 20 rpm. It is not uncommon for the drill unit to stall before the tap is completely seated. Final seating of the Short Dense Bone Tap may require the use of the Ratchet Extension and the Ratchet Wrench. To avoid stripping the site, be careful not to tap beyond the osteotomy depth.

- Instruments needed:
Handpiece Connector (MDR10) 6.0 mm Short Dense Bone Tap (TAP66S)
Ratchet Extension (RE100 or RE200) Ratchet Wrench (WR150) or High Torque
Indicating Ratchet Wrench (H-TIRW)

Proceed to step 1 on page 16 for implant placement.



No-Touch™ Delivery System

1. Remove contents from the implant box.

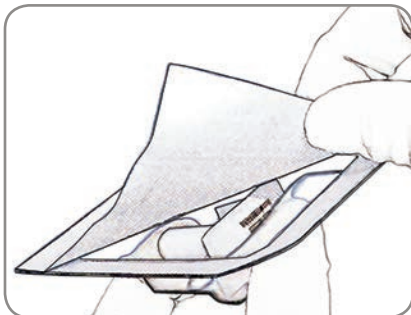

2. The nonsterile assistant should peel back the tray lid and drop the No-Touch Implant Tray onto the sterile drape.



3. Wearing sterile gloves, place the No-Touch Implant Tray into the appropriate location onto the surgical tray.



4. Peel back the tray lid to expose the implant and cover screw.



5. Pick up the implant from the surgical tray using the Handpiece Connector. Carry the implant to the mouth facing upward to prevent accidental dislodging.

- Instrument needed:
Handpiece Connector (MDR10)



6. Place the implant into the prepared site at approximately 15 – 20 rpm. It is not uncommon for the Handpiece Connector to stall before the implant is completely seated.

Tapping with a Dense Bone Tap is required in dense bone (type I).

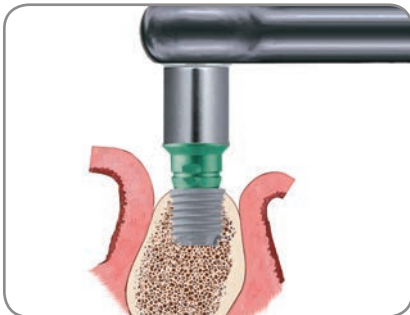

7. Final seating of the implant may require the use of a Ratchet Extension and Ratchet Wrench.

Exceeding insertion torque of more than 90 Ncm may deform or strip the implant placement mount or the implant's external hex and may possibly delay the surgical procedure.

- Instruments needed:
Ratchet Extension (RE100 or RE200)
Ratchet Wrench (WR150) or High Torque Indicating Ratchet Wrench (H-TIRW)

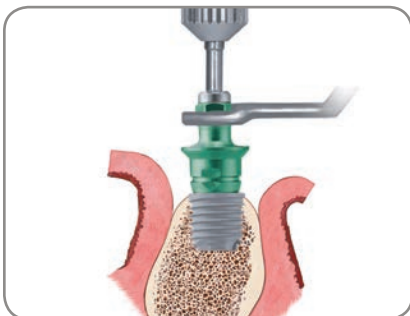

8. To remove the implant mount, place the Open End Wrench onto the mount. Loosen the screw at the top of the mount with a Large Hex Driver or Large Hex Driver Tip inserted into the Right-Angle Driver or Low Torque Indicating Ratchet Wrench and rotate counter-clockwise. After the screw is completely loosened, rotate the Open End Wrench counter-clockwise slightly before removing the mount. The mount can be carried from the mouth with the Open End Wrench.

- Instruments needed:
Open End Wrench (CW100), Large Hex Driver Tip (RASH3)* and Right-Angle Driver (CATDB with CADD1)* or Large Hex Driver (PHD02N) or Low Torque Indicating Ratchet Wrench (L-TIRW)

* RASH3 and CATDB are not included in the T3 Short Implant Kit.

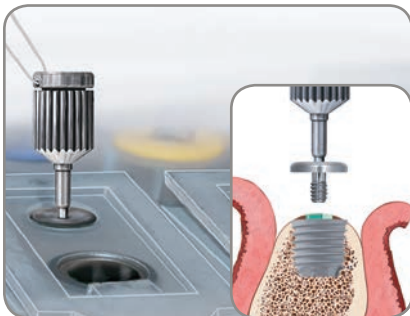

9. If performing a two-stage protocol, pick up the Cover Screw from the No-Touch Implant Tray with the Small Hex Driver (PHD00N) and place it onto the implant at no more than 10 Ncm. Thread a suture through the hole to prevent accidental swallowing.

- Instrument needed:
Small Hex Driver (PHD00N)

NOTE: At this step, a temporary healing abutment may also be placed instead of a cover screw when performing a single-stage treatment protocol. See page 19.

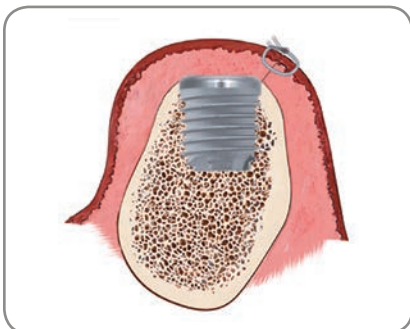

10. Reposition the soft-tissue flaps and secure with sutures.



1. For surgical implant placement of a T3 Short Implant, follow the normal protocol as described in the previous sections.

A surgical index can be made at stage one or stage two of surgery to facilitate the fabrication of a provisional restoration. This can be accomplished by using a Pick-Up Impression Coping (or a Hexed Temporary Cylinder) with retention, a waxing screw and medium-to-heavy body impression material.

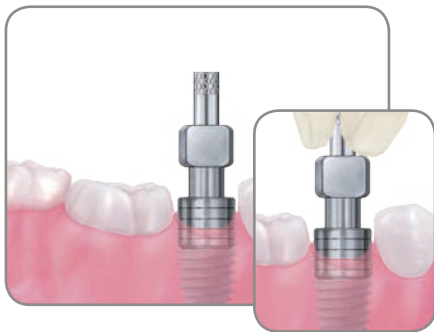

2. Select the proper Pick-Up Impression Coping by matching the diameter of the implant platform.

Place the Pick-Up Impression Coping or the Temporary Cylinder onto the implant and engage the hex.

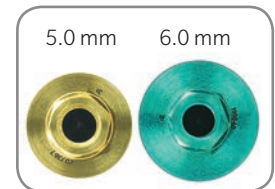

Thread the Pick-Up Impression Coping Screw or waxing screw into the implant until finger tight. Tighten the screw using the Large Hex Driver. If the Impression Coping touches the adjacent teeth, the impression coping may need to be modified with a bur or disc.



3. Syringe medium-to-heavy body impression material around the impression coping or temporary cylinder and over the occlusal surfaces of the adjacent teeth (approximately 1.5 teeth on either side). Allow the impression material to set per the manufacturer's instructions. Once the material has set, remove the impression coping screw or waxing screw using the Large Hex Driver. Remove the surgical index from the mouth. Send the index to the restorative clinician so that it may be included in the package to the laboratory. Do not place a lab analog into the index.

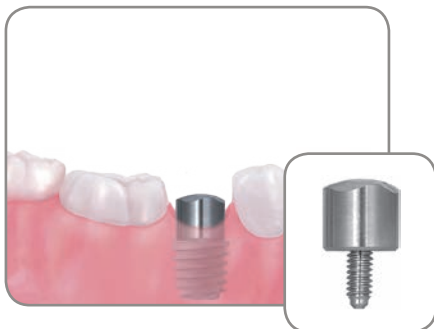

4. Select the appropriate one-piece healing abutment or a BellaTek® Encode® Healing Abutment, depending on the implant seating surface (or platform size if manual platform switching is desired), tissue depth and desired emergence profile dimension. Tighten the healing abutment to 20 Ncm and secure the soft-tissue flaps around it with intermittent sutures.

There may be several advantages to utilizing a two-stage implant system in a single-stage treatment protocol. Attaching a one-piece or two-piece healing abutment immediately following implant placement eliminates the need for a second-stage surgery. Eliminating the second surgical procedure reduces trauma and decreases treatment time, while the two-stage implant design maintains restorative flexibility.

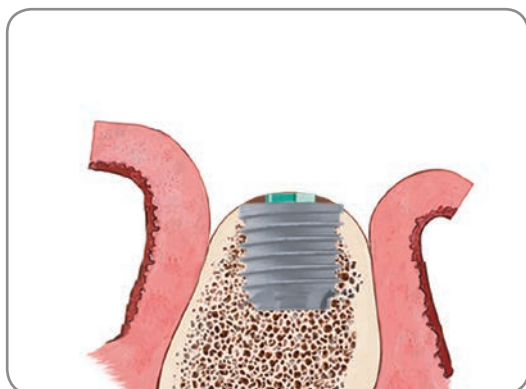

1. Fully seat the implant and remove the implant mount.

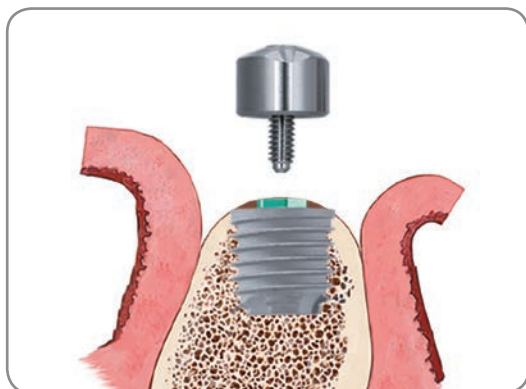

2. Select the appropriate one-piece healing abutment or a BellaTek Encode Healing Abutment, depending on the implant seating surface (or platform size if manual platform switching is desired), tissue depth and desired emergence profile dimension.

Manually platform switching the healing and definitive abutment may aid in preserving crestal bone and tissue height.

Bone profiling of the osteotomy may be necessary to fully seat the healing abutment onto the implant.

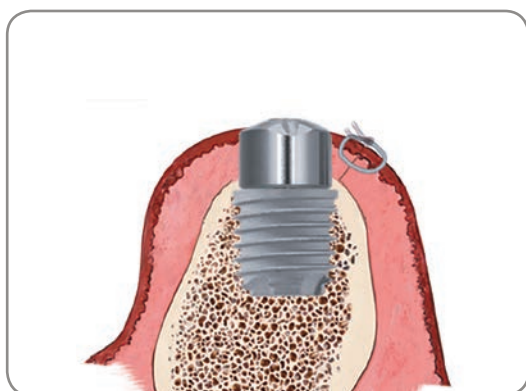

3. Tighten the one or two-piece healing abutment screw to 20 Ncm and secure the soft-tissue flaps around it with intermittent sutures.



5.0 mmD External Hex Implants	
Item #	Description
BOES505	5.0 mmD x 5.0 mmL
BOES506	5.0 mmD x 6.0 mmL

5.0 mmD External Hex Implants with DCD® Surface	
Item #	Description
BNES505	5.0 mmD x 5.0 mmL
BNES506	5.0 mmD x 6.0 mmL



6.0 mmD External Hex Implants	
Item #	Description
BOES605	6.0 mmD x 5.0 mmL
BOES606	6.0 mmD x 6.0 mmL

6.0 mmD External Hex Implants with DCD Surface	
Item #	Description
BNES605	6.0 mmD x 5.0 mmL
BNES606	6.0 mmD x 6.0 mmL

Recommended Healing Abutments For Platform Switching

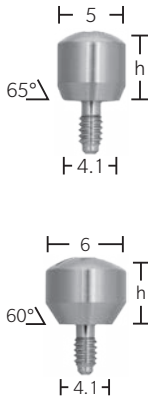

4.1 mmD Seating Surface		Emergence Profile	Collar Height
Item #			
THA52	5.0 mm	5.0 mm	2.0 mm
THA53	5.0 mm	5.0 mm	3.0 mm
THA54	5.0 mm	5.0 mm	4.0 mm
THA56	5.0 mm	5.0 mm	6.0 mm
THA58	5.0 mm	5.0 mm	8.0 mm
THA63	6.0 mm	6.0 mm	3.0 mm
THA64	6.0 mm	6.0 mm	4.0 mm
THA66	6.0 mm	6.0 mm	6.0 mm
THA68	6.0 mm	6.0 mm	8.0 mm
THA73	7.5 mm	7.5 mm	3.0 mm
THA74	7.5 mm	7.5 mm	4.0 mm
THA76	7.5 mm	7.5 mm	6.0 mm
THA78	7.5 mm	7.5 mm	8.0 mm

Recommended Healing Abutments For Platform Switching

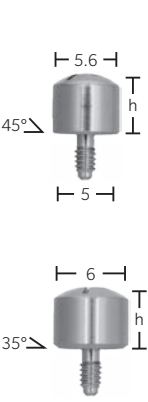

5.0 mmD Seating Surface		Emergence Profile	Collar Height
Item #			
WTH52	5.6 mm	5.6 mm	2.0 mm
WTH53	5.6 mm	5.6 mm	3.0 mm
WTH54	5.6 mm	5.6 mm	4.0 mm
WTH56	5.6 mm	5.6 mm	6.0 mm
WTH58	5.6 mm	5.6 mm	8.0 mm
WTH562	6.0 mm	6.0 mm	2.0 mm
WTH563	6.0 mm	6.0 mm	3.0 mm
WTH564	6.0 mm	6.0 mm	4.0 mm
WTH566	6.0 mm	6.0 mm	6.0 mm
WTH568	6.0 mm	6.0 mm	8.0 mm
WTH572	7.5 mm	7.5 mm	2.0 mm
WTH573	7.5 mm	7.5 mm	3.0 mm
WTH574	7.5 mm	7.5 mm	4.0 mm
WTH576	7.5 mm	7.5 mm	6.0 mm
WTH578	7.5 mm	7.5 mm	8.0 mm

BSISK T3 Short Implant Surgical kit

This product is not available in all markets. Please contact your local Zimmer Biomet Sales Representative for availability in your market. Refer to the Surgical Catalog (INSTSUR) for more options.



Contact us at 1-800-342-5454 or visit
zimmerbiometdental.com

Zimmer Biomet Dental
Global Headquarters
4555 Riverside Drive
Palm Beach Gardens, FL 33410
Tel: +1-561-776-6700
Fax: +1-561-776-1272

Unless otherwise indicated, as referenced herein, all trademarks are the property of Zimmer Biomet; and all products are manufactured by one or more of the dental subsidiaries of Zimmer Biomet Holdings, Inc., and distributed and marketed by Zimmer Biomet Dental (and, in the case of distribution and marketing, its authorized marketing partners). For additional product information, please refer to the individual product labeling or instructions for use. Product clearance and availability may be limited to certain countries/regions. This material is intended for clinicians only and does not comprise medical advice or recommendations. This material may not be copied or reprinted without the express written consent of Zimmer Biomet Dental. ZBINSTMT3S REV B 12/17 ©2017 Zimmer Biomet, All rights reserved.

